

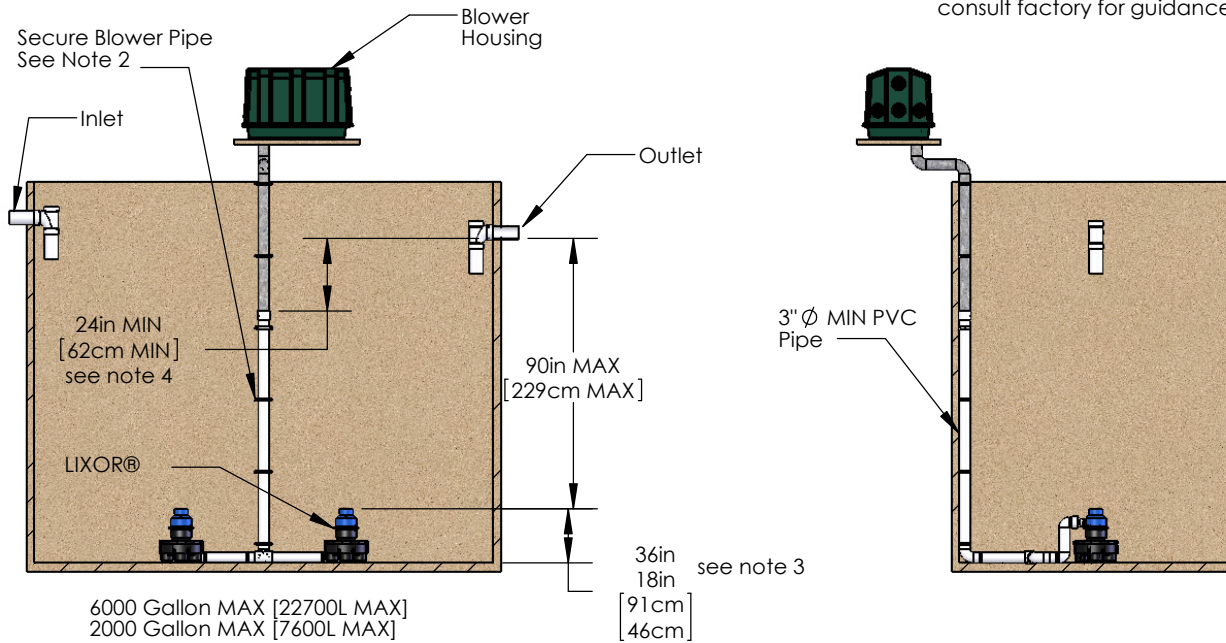

**NOTES**

1. Blower piping to LIXOR® may not exceed 50 FT [15m] in total length and use a maximum of 8 elbows to get to the LIXOR. For distances greater than 50 FT [15m] - consult factory. Blower must be located above flood/standing water levels on a concrete base 42" X 28" X 2" [105 X 70 X 5 cm] minimum.
2. The air supply line must be secured with a non-corrosive clamp every 2' [0.6m] minimum to prevent vibration induced damage.
3. LIXOR height without extension is 18" [46cm]. Maximum Extension of 18" [46cm]. Consult factory for extensions greater than 12" [30cm].
4. 3" Ø stainless steel piping system must extend 24" [61 cm] below the water line. All pipe up to the LIXOR unit shall be 3" Ø pipe and transition at the LIXOR to a 1.5" Ø PVC pipe.
5. LIXOR® units should be evenly spaced in the tank for optimal performance.
6. All appurtenances (e.g. tank pump outs, etc.) must conform to all country, state, province, and local plumbing and electrical codes. The blower control system is provided by Bio-Microbics, Inc.
7. If settling zone is used either the influent pipe tee of the settling zone shall be fitted with a pipe cap or the baffle separating the settling zone and LIXOR aeration zone shall be extended to the top of the tank. If choosing to use the pipe cap, then the baffle shall be at least 3" [8cm] higher than the water level. Settling zone is not shown.
8. Tank must be secured to prevent accidental or unauthorized access.
9. Tank, anchors, piping, conduit, blower housing pad and vents are provided by others.
10. Installation of the LIXOR® shall be done in accordance with the provided written instructions. Refer to installation manual for more details.
11. If less than the specified minimum or more than the specified maximum is considered necessary, consult factory for guidance.



DO NOT SCALE		 BETTER WATER. BETTER WORLD.®		LIXOR 2.0	
UNLESS NOTED DIMENSIONS ARE IN INCHES [CENTIMETERS] TOLERANCES ± 0.02 IN/IN [± 0.05 CM/CM]					
WEIGHT	lb	SIZE	DRAWING NUMBER		
		A	LIXOR® 2.0 Open Tank		
DRAWN	CTC	DATE	REVISED 4/14/2014		
		8/17/2005	REV. INI-01-A+		
CHECKED	PF	4/14/2014			

THE INFORMATION CONTAINED IN THIS DRAWING IS THE SOLE PROPERTY OF BIO-MICROBICS INC. ANY REPRODUCTION IN PART OR AS A WHOLE WITHOUT THE WRITTEN PERMISSION OF BIO-MICROBICS INC. IS PROHIBITED. DESIGN AND INVENTION RIGHTS ARE RESERVED. IN THE INTEREST OF TECHNOLOGICAL ADVANCEMENT, ALL PRODUCTS ARE SUBJECT TO DESIGN AND OR MATERIAL CHANGE WITHOUT NOTICE.

BIO-MICROBICS © 2014

SHEET 1 OF 4

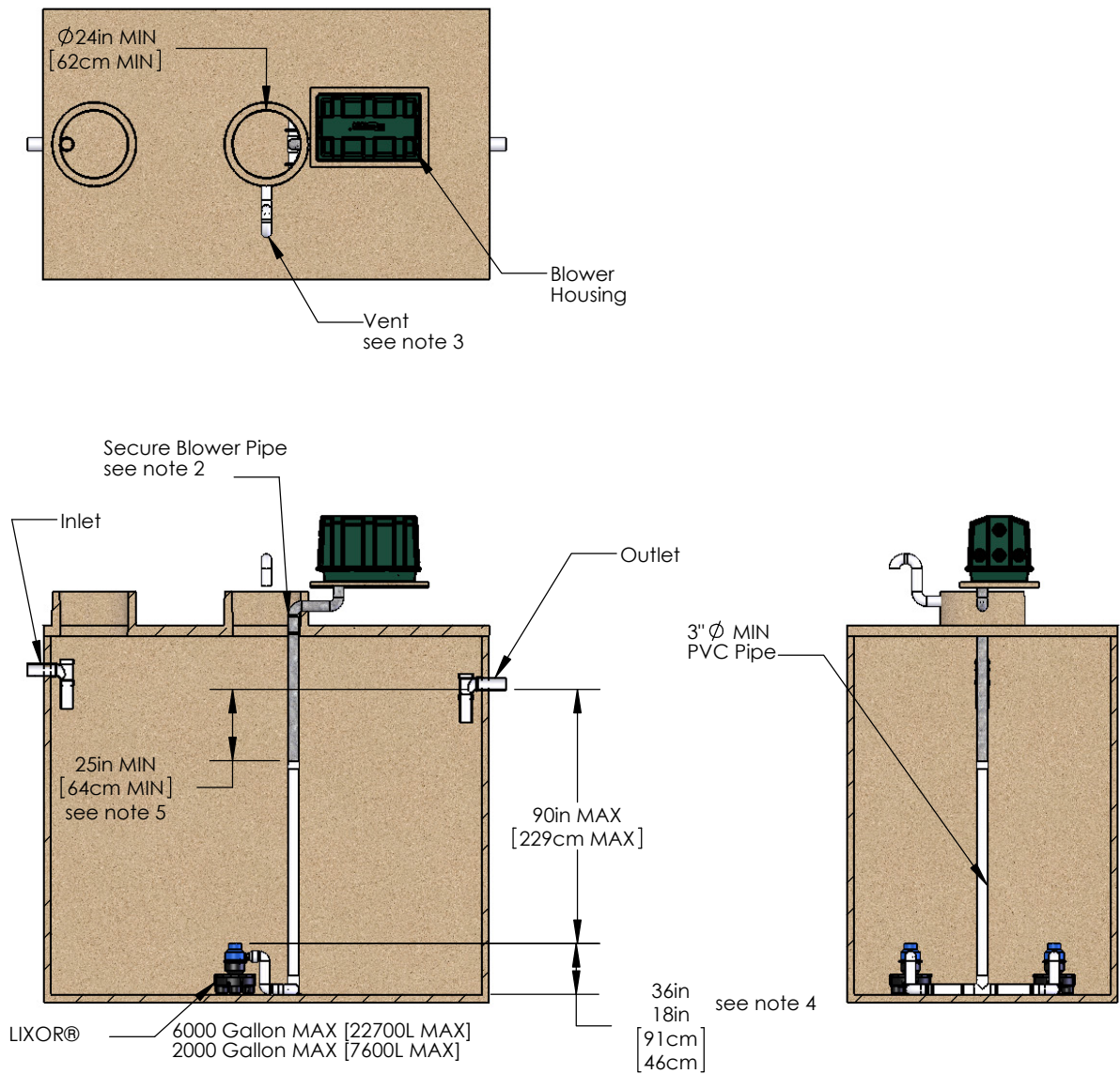

**NOTES**

1. Blower piping to LIXOR® may not exceed 50 FT [15m] in total length and use a maximum of 6 elbows, to get to the tank. For distances greater than 50 FT [15m] - consult factory. Blower must be located above flood/standing water levels on a concrete base 42" X 28" X 2" [105 X 70 X 5 cm] minimum.
2. The air supply line must be secured with a non-corrosive clamp every 2' [0.6m] minimum to prevent vibration induced damage.
3. Vent to desired location and cover opening with a vent grate with at least 7 sq in. [45 sq. cm] open surface area. Secure with stainless steel screws. Vent piping must not allow condensate build up or create back pressure. Vent must be above finished grade or higher.
4. LIXOR height without extension is 18" [46cm]. Maximum Extension of 18" [46cm]. Consult factory for extensions greater than 12" [30cm].
5. 3" Ø stainless steel piping system must extend 24" [61cm] below the water line. All pipe up to the LIXOR unit shall be 3" Ø pipe and transition at the LIXOR to a 1.5" Ø PVC pipe.
6. LIXOR® units should be evenly spaced in the tank for optimal performance.
7. All appurtenances (e.g. tank pump outs, etc.) must conform to all country, state, province, and local plumbing and electrical codes. The blower control system is provided by Bio-Microbics, Inc.
8. The tank(s) shall be designed to prevent septic odors passing from the settling zone/tank to the treatment zone. Examples include a baffle wall sealed to the lid, and treatment zone inlet line with a pipe cap. Consult factory for guidance.
9. All inspection, viewing and pump out ports must be secured to prevent accidental or unauthorized access.
10. Tank, anchors, piping, conduit, blower housing pad and vents are provided by others.
11. Installation of the LIXOR® shall be done in accordance with the provided written instructions. Refer to installation manual for more details.
12. If less than the specified minimum or more than the specified maximum is considered necessary, consult factory for guidance.

DO NOT SCALE		 BETTER WATER. BETTER WORLD.®		LIXOR 2.0	
UNLESS NOTED DIMENSIONS ARE IN INCHES [CENTIMETERS] TOLERANCES ± 0.02 IN/IN [± 0.05 CM/CM]					
WEIGHT	lb	SIZE	DRAWING NUMBER		
		A	LIXOR® 2.0 Riser Mount		
DRAWN	CTC	DATE	SHEET 2 OF 4		
		8/17/2005			
CHECKED	PF	4/14/2014	REVISED	4/14/2014	REV. INI-05-X

THE INFORMATION CONTAINED IN THIS DRAWING IS THE SOLE PROPERTY OF BIO-MICROBICS INC. ANY REPRODUCTION IN PART OR AS A WHOLE WITHOUT THE WRITTEN PERMISSION OF BIO-MICROBICS INC. IS PROHIBITED. DESIGN AND INVENTION RIGHTS ARE RESERVED. IN THE INTEREST OF TECHNOLOGICAL ADVANCEMENT, ALL PRODUCTS ARE SUBJECT TO DESIGN AND OR MATERIAL CHANGE WITHOUT NOTICE.

BIO-MICROBICS © 2014

Specifications for LIXOR® 2.0 Aeration System

1. GENERAL  
The contractor shall furnish and install (1) LIXOR® 2.0 aeration system as manufactured by Bio-Microbics, Inc. The aeration system shall be complete with all needed equipment as shown on the drawings and specified herein. The principal items of equipment shall include LIXOR® aerator, blower assembly, optional blower controls and alarms. All other items will be provided by others. The LIXOR® 2.0 system shall be situated within a 6000 Gallon [22700L] maximum compartment or tank as shown on the plans. Tank(s) must provide adequate pump out access and conform to local, state, and all other applicable codes. The contractor shall provide coordination between the LIXOR® system and tank supplier regarding fabrication of the tank, installation of the LIXOR® unit and delivery to the job site.
2. OPERATING CONDITIONS  
The LIXOR® 2.0 system shall be capable of providing supplemental oxygen in treating wastewater requiring higher oxygen demand than the wastewater generated by the typical residential activities (bath, laundry, kitchen, etc.). The LIXOR® 2.0 system shall be capable of transferring oxygen to meet 6 to 10 pounds per day BOD demand of the wastewater.
3. LIXOR AERATOR  
The LIXOR® aerator shall be manufactured of rigid PVC and ABS. The aerator shall be fixed in position and contain no moving or wearing parts and shall not corrode. The aerator shall be designed and installed to ensure that the content of the tank is well mixed and aerobic.
4. BLOWER  
The LIXOR® 2.0 system shall come equipped with a regenerative type blower capable of delivering 20-50 CFM [34-85 m3/hr]. The blower assembly shall include an inlet filter with metal filter element.
5. REMOTE MOUNTED BLOWER  
The blower shall be mounted, up to 50 feet [15 meters] maximum, from the LIXOR® unit on a contractor supplied concrete base. The blower must not set in standing water and its elevation must be higher than the normal flood level. A two-piece, rectangular housing shall be provided. The discharge air line from the blower to the LIXOR® unit shall be provided and installed by the contractor. All pipe up to the LIXOR unit shall be 2" Ø pipe and transition at the LIXOR to a 1.5"[60mm] PVC pipe.
6. ELECTRICAL  
The electrical source should be within 150 feet [45.7 meters] of the blower consult local codes for longer wiring distances. All wiring must conform to all applicable codes (IEC, NEC, etc.). Wiring distances must prevent significant voltage loss. Input power on 60Hz electrical system is 1Ø-3Ø, 220-208/460 VAC, and maximum 12-6.3/2.9 FLA. Input power on 50Hz electrical system is 1Ø-3Ø, 220-230/400 VAC, and maximum 12-6.1/3.5 FLA. All conduit and wiring shall be supplied by contractor.
7. CONTROLS  
The optional control panel provides power to the blower with an alarm system consisting of a visual and audible alarm capable of signaling blower circuit failure and high water conditions. The control panel is equipped with SFR® timed control feature. A manual silence button is included.
8. INSTALLATION AND OPERATING INSTRUCTIONS  
All work installation and connections of the LIXOR® 2.0 shall be done in accordance with the written instructions provided by the manufacturer and in accordance with all applicable local codes and regulations. Operations manuals shall be furnished which will include a description of installation, operation, and system maintenance procedures.
9. FLOW AND DOSING  
LIXOR® systems have been successfully designed, tested and certified receiving gravity, demand-based influent flow. When influent flow is controlled by pump or other means to help with highly variable flow conditions, then multiple dosing events should be used to help ensure even flow.
10. WARRANTY  
Bio-Microbics, Inc. warrants all new LIXOR® models (LIXOR® 0.50, 1.0, 2.0, 3.0, 4.0, 4.0XD, 6.0, 6.0XD, 8.0, and 8.0XD) against defects in materials and workmanship for a period of one year after installation or eighteen months from date of shipment which ever occurs first, subject to the following terms and conditions:  
During the warranty period, if any part is defective or fails to perform as specified when operating at design conditions, and if the equipment has been installed and is being operated and maintained in accordance with the written instructions provided by Bio-Microbics, Inc., Bio-Microbics, Inc. will repair or replace at its discretion such defective parts free of charge. Defective parts must be returned by owner to Bio-Microbics, Inc.'s factory postage paid, if so requested. The cost of labor and all other expenses resulting from replacement of the defective parts and from installation of parts furnished under this warranty and regular maintenance items such as filters or bulbs shall be borne by the owner. This warranty does not cover: general system misuse, aerator components which have been damaged by flooding or any components that have been disassembled by unauthorized persons, improperly installed or damaged due to altered or improper wiring or overload protection. This warranty applies only to the LIXOR® system and does not include any of the structure wiring, plumbing, drainage, septic tank or disposal system. Bio-Microbics, Inc. reserves the right to revise, change or modifies the construction and/or design of the LIXOR® system, or any component part or parts thereof, without incurring any obligation to make such changes or modifications in present equipment. Bio-Microbics, Inc. is not responsible for consequential or incidental damages of any nature resulting from such things as, but not limited to, defect in design, material, or workmanship, or delays in delivery, replacements or repairs.  
THIS WARRANTY IS IN LIEU OF ALL OTHER WARRANTIES EXPRESS OR IMPLIED. BIO-MICROBICS SPECIFICALLY DISCLAIMS ANY IMPLIED WARRANTY OF MERCHANTABILITY OR FITNESS FOR A PARTICULAR PURPOSE. NO REPRESENTATIVE OR PERSON IS AUTHORIZED TO GIVE ANY OTHER WARRANTY OR TO ASSUME FOR BIO-MICROBICS, INC., ANY OTHER LIABILITY IN CONNECTION WITH THE SALE OF ITS PRODUCTS. Contact your local distributor for parts and service.

DO NOT SCALE				LIXOR 2.0	
UNLESS NOTED DIMENSIONS ARE IN INCHES [CENTIMETERS] TOLERANCES ± 0.02 IN/IN [± 0.05 CM/CM]					
WEIGHT lb		SIZE	DRAWING NUMBER		
NAME DATE		A	2.0 Specifications		
DRAWN 8/17/2005		REVISED 4/14/2014		REV.	
CHECKED PF 4/14/2014					

THE INFORMATION CONTAINED IN THIS DRAWING IS THE SOLE PROPERTY OF BIO-MICROBICS INC. ANY REPRODUCTION IN PART OR AS A WHOLE WITHOUT THE WRITTEN PERMISSION OF BIO-MICROBICS INC. IS PROHIBITED. DESIGN AND INVENTION RIGHTS ARE RESERVED. IN THE INTEREST OF TECHNOLOGICAL ADVANCEMENT, ALL PRODUCTS ARE SUBJECT TO DESIGN AND OR MATERIAL CHANGE WITHOUT NOTICE.

BIO-MICROBICS © 2014

SHEET 3 OF 4

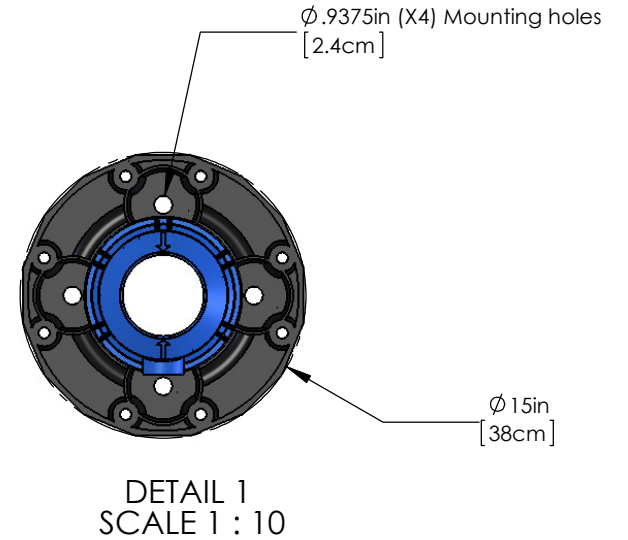
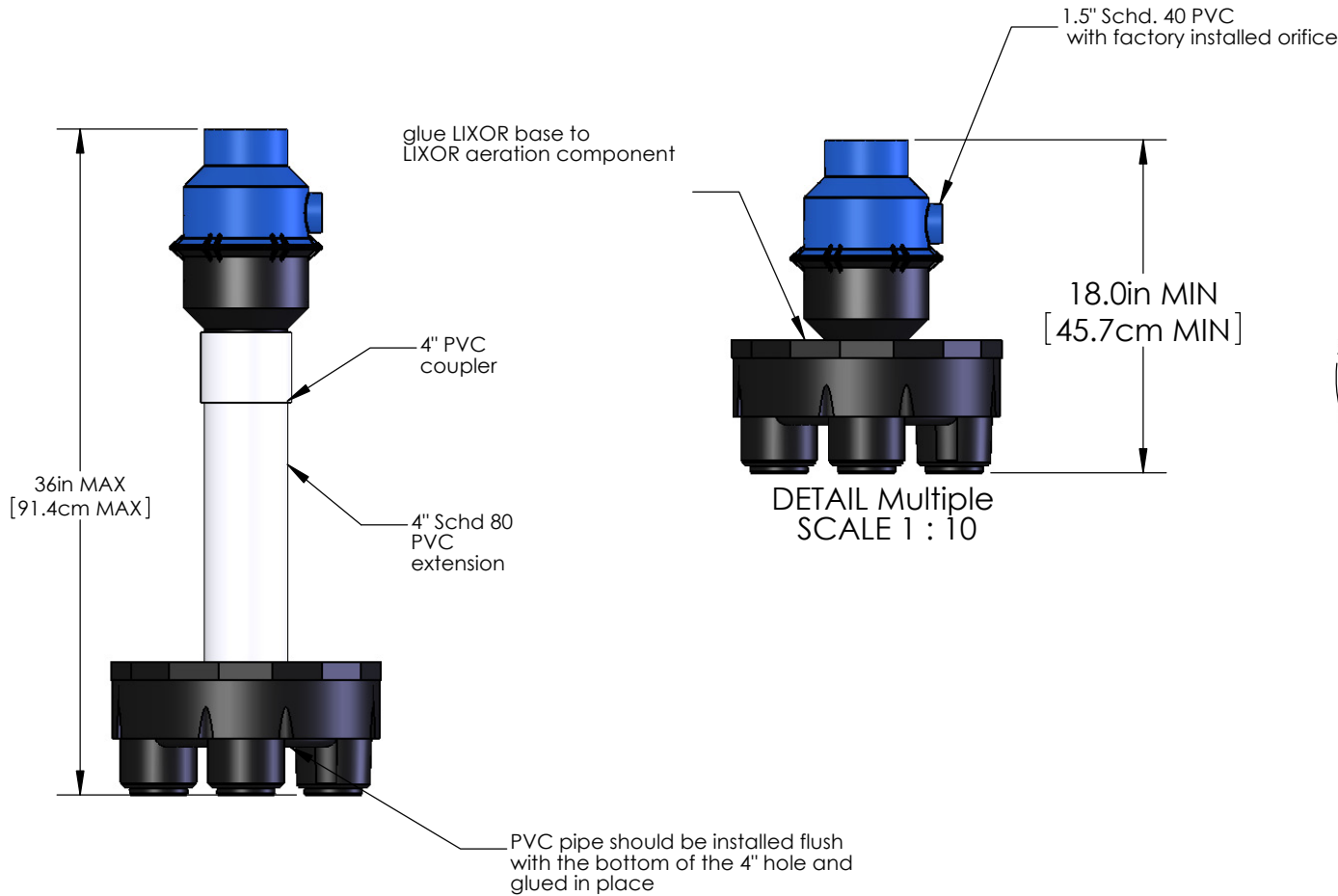

**DETAIL Optional Extension  
SCALE 1 : 10**

When installing the extension, to meet your optimum air release depth glue, all fittings together with standard PVC glue.

DO NOT SCALE  
UNLESS NOTED  
DIMENSIONS  
ARE IN INCHES  
[CENTIMETERS]  
TOLERANCES  
± 0.02 IN/IN  
[± 0.05 CM/CM]



LIXOR 2.0

THE INFORMATION CONTAINED IN THIS DRAWING IS THE SOLE PROPERTY OF BIO-MICROBICS INC. ANY REPRODUCTION IN PART OR AS A WHOLE WITHOUT THE WRITTEN PERMISSION OF BIO-MICROBICS INC. IS PROHIBITED. DESIGN AND INVENTION RIGHTS ARE RESERVED. IN THE INTEREST OF TECHNOLOGICAL ADVANCEMENT, ALL PRODUCTS ARE SUBJECT TO DESIGN AND OR MATERIAL CHANGE WITHOUT NOTICE.

BIO-MICROBICS © 2014

WEIGHT	lb	SIZE	DRAWING NUMBER		SHEET 4 OF 4
NAME	DATE	A	Details		
DRAWN	CTC 8/17/2005		REVISED 4/14/2014		
CHECKED	PF 4/14/2014		REV. INI-01-A+		